

99098

Dimensions

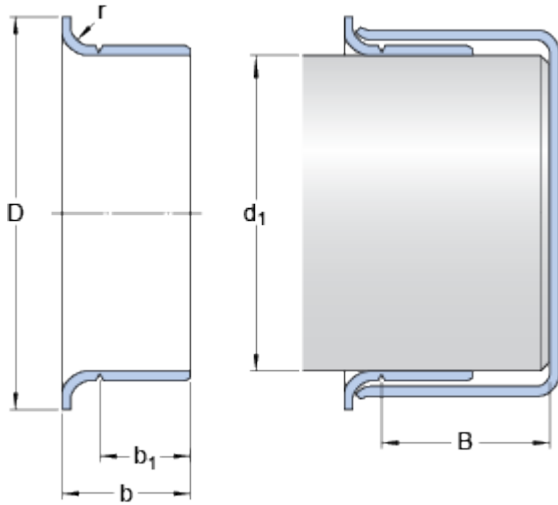

Nominal dimensions

d_1		25	mm
D		33.02	mm
Tolerance outside diameter D	\pm	1.6	mm
b		10.998	mm
Tolerance width b	\pm	0.8	mm
b_1		7.95	mm
Tolerance width b_1	\pm	0.8	mm
B	max.	50.8	mm
r	max.	3.18	mm

Shaft diameter range

d_1	min.	24.943	mm
d_1	max.	25.044	mm